

Intraoral Scanner

Instructions for Use

Original

Model 100

Model 001



CONTENTS

1. About this guide	3
1.1 Disclaimer	3
1.2 License, trademarks and other rights	4
2. Introduction and overview	6
2.1 Intended use	6
2.2 Device description and features	6
2.3 Accessories and products used in combination	7
2.4 Indications	8
2.5 Precautions	8
2.6 Compatibility information	10
2.7 Data protection	10
2.8 Further information	11
2.9 Disposal	14
3. Installation	15
3.1 Unpacking the scanner	15
3.2 Setting up the scanner	16
4. Basic principles and user interface	22
5. Scanning	27
5.1 Accuracy	27
5.2 Step-by-step	27
6. Maintenance	31
6.1 Handling	31
6.2 Reprocessing	32
6.3 Data backup	35
6.4 Maintenance tools	35
6.5 Changing fine fuses	39
6.6 Service	39
7. Troubleshooting	41
8. Packing the scanner	44
9. Distributors and service	46
10. Technical data and label	47
11. Explanation of symbols	54
Appendix A - Reprocessing of the handpiece sleeve	56
Appendix B - Reprocessing of the Intraoral Scanner (without handpiece sleeve)	61
Appendix C - Electromagnetic Compatibility Guideline	65

1. About this guide

Caution

The provided instructions contain important information on the safe and appropriate use of your scanner and its software. Make sure to have read and understood this document prior to installing and operating the device.

These Instructions for Use are valid for the product life cycle of your device and its software unless new instructions are published within this period. In case of questions, contact your local distributor. Please keep this document for future reference.

The term "scanner" refers to any and all Intraoral Scanner models, including their parts and accessories. The term "scanner unit" refers to the scanner component used to process scans. The term "handpiece" includes both the handpiece and its sleeves.

Electronic Instructions for Use

Instructions for Use for your scanner are provided in electronic form. They are stored on your scanner and also available through the eIFU website. If a paper version is required, the user may print these instructions himself/herself or request a paper version from the manufacturer. For further information, delivery time and contact details see eIFU website: <https://ifu.dentalwings.com>

1.1 Disclaimer

This device is designed for use by persons who have appropriate knowledge in dentistry and dental laboratory technology.

The user of this device is solely responsible for determining whether or not this device is suitable for a particular patient case and circumstances. The user is solely responsible for the correctness, completeness and adequacy of all data entered into this device and the used software. The user must check the correctness of the results and assess each individual case.

Dental Wings products must be used in accordance with their accompanying instructions for use. Improper use or handling of Dental Wings products will void the warranty, if any, given for Dental Wings products. If you require additional information on the proper use of Dental Wings products, contact your local distributor. The user is not allowed to modify Dental Wings products.

DENTAL WINGS, ITS AFFILIATES OR DISTRIBUTORS DISCLAIM REPRESENTATIONS AND WARRANTIES OF ANY KIND, WHETHER EXPRESSED OR IMPLIED, WRITTEN OR ORAL, WITH RESPECT TO THE PRODUCTS, INCLUDING ANY WARRANTY OF MERCHANTABILITY, FITNESS FOR A PARTICULAR PURPOSE, ERROR-FREE OPERATION OR NON-INFRINGEMENT, AND THE PRODUCTS ARE SOLD "AS IS".

Our maximum liability arising out of the products or their use, whether based upon warranty, contract, tort or otherwise, shall not exceed the actual payments received by us in respect of the purchase price thereof. In no event shall we be liable for special, incidental or consequential damages, including, but not limited to, loss of profits, loss of data or loss of use damages, arising hereunder or from the sale of the products.

Updates to hardware and software components are made regularly. Therefore, some of the instructions, specifications and pictures contained in these Instructions for Use may differ slightly from your particular situation. Dental Wings reserves the right to revise or make changes or improvements to this product or documentation at any time without obligation to notify any person of such revisions or improvements.

Third party products and product data

When scanning and designing cases, the user may work with third party products and/or product data. Dental Wings, its subsidiaries, or distribution partners disclaim any liability for damages in connection with or arising from such third party product data or products being used within this scope.

1.2 License, trademarks and other rights

Software license

Your scanner software is protected by a license agreement and may be used or copied only in accordance with the terms of this agreement. It is illegal to copy or use the software on any medium except those permitted in the license agreement.

Availability

Some of the products and accessories mentioned in these Instructions for Use may not be available in all countries.

Trade names and trademarks

DENTAL WINGS and/or other trademarks and registered trademarks from Dental Wings mentioned herein are the trademarks or registered trademarks of Dental Wings. All other trademarks are the property of their respective owners.

Copyright

Dental Wings documents may not be reprinted or published, in whole or in part, without the written authorization of Dental Wings.

2. Introduction and overview

2.1 Intended use

The Intraoral Scanner is a dental 3D scanner intended to be used to digitally record topographical characteristics of teeth and surrounding tissues. The system produces 3D scans for use in computer-assisted design and manufacturing of dental restorations.

2.2 Device description and features

The Intraoral Scanner consists of a computer with embedded software, a monitor, and a handpiece equipped with optical sensors.

Variants

The Intraoral Scanner (Type: DW-IO) is delivered in two product variants (see *Instructions for Use*, p. 1):

- Model 001 (cart) - Article No. 6000-1
- Model 100 (laptop) - Article No. 6300-1

The delivery contains all components necessary to run the Intraoral Scanner as intended. For details, see *Parts identification*, p. 17.

Notes

1. The laptop (scanner unit of Model 100) can be replaced by the scanner unit of Model 010 (portable).
2. Distributors may acquire laptops for Model 100, install the software, and validate the installation. For further details, see *Technical data and label*, p. 47.

Caution

Laptops must comply with national safety regulations and be validated for use with the Intraoral Scanner to ensure adequate performance. Refer to the information available for distributors.

Configurations

The device is delivered in the following configurations:

- With the distributor logo and color
- With a distributor-specific set of accessories
- With a distributor-specific software configuration
- With a country-specific power cord

Principles of operation

Sensors in the handpiece of the Intraoral Scanner provide data, which is matched to each other in the processing unit to create a digital impression.

Novel features

The Intraoral Scanner does not contain novel features in relation to conventional dentistry. It supports digital realization of conventional dental services in the area of restorative prosthetic.

2.3 Accessories and products used in combination

The use of the Intraoral Scanner requires accessories (cleaning and disinfection products, standard packaging material). Moreover, it can be used in combination with other products (e.g. CAD/CAM software).

Dental Wings has validated the specific products given in chapter *Technical data and label* (see *Replacement parts*, p. 52), in *Appendix A - Reprocessing of the handpiece sleeve* (p. 56) and in *Appendix B - Reprocessing of the Intraoral Scanner (without handpiece sleeve)* (p. 61). Others may be suitable as well if they meet the requirements below. However, the user has to validate their compatibility with the Intraoral Scanner.

The scanner is available in different configurations. For device variants and optional PC peripherals, see chapter *Device description and features* (p. 6). For information on specific accessories, contact your local distributor.

Reprocessing

The Intraoral Scanner requires reprocessing. The particular use, specific requirements, as well as validated products for the reprocessing material and equipment are found in Appendices A and B.

Cleaning and disinfection products : The scanner requires reprocessing with specific detergents and disinfectants. They are specified in Appendices A and B.

The handpiece sleeve is a semicritical area and requires sterilization. The handpiece (without sleeve), the cable, the scanner unit, and the accessories are noncritical areas and require intermediate or low level disinfection.

Standard packaging material : Standard see-through sterilization pouch shall be used to protect the handpiece after reprocessing. A size of 9 cm x 20 cm is required. In addition, a standard plastic bag may be used to store the complete handpiece. A minimum size of 25 cm x 40 cm is required.

Further use of 3D scans

3D scans from the Intraoral Scanner may be used with other software products. It is required that such products can handle open STL files. Dental Wings has validated the use of:

DWOS: 3D dental restorations design software

Straumann® CARES® Visual: 3D dental restorations design software

coDiagnostiX: Dental surgery treatment planning software

2.4 Indications

The scanner is an intraoral optical 3D scanning device intended to be used to digitally record topographical characteristics of teeth and surrounding tissues. The system produces 3D scans for use in computer-assisted design and manufacturing of dental restorations. The 3D scan is provided in a 3D geometry format. The device allows several scanner heads embedded in the handpiece to scan at once from multiple angles. It is intended to be used by dental professionals.

2.5 Precautions

The provided instructions contain important information on the safe and appropriate use of your scanner and its software. Make sure to have read and understood this document prior to installing and operating the device.

Laptops must comply with national safety regulations and be validated for use with the Intraoral Scanner to ensure adequate performance. Refer to the information available for distributors.

This scanner is capable of very precise scanning. To achieve scanning accuracy, comply with all the given instructions.

The Intraoral Scanner (cart model) is a protection class I device. To avoid risk of electric shock it shall only be connected to a power outlet with protective earthing.

The scanner is suitable for use in laboratories, dental offices and equivalent environment. However, the protection against dust and water has not been specifically tested.

Install the scanner in accordance with the instructions. Before any maintenance action, unplug the scanner from the power outlet.

The handpiece must be connected to the scanner unit prior to being used on patients. Make sure that the handpiece/handpiece connector is plugged in the scanner unit before the handpiece comes into contact with patients.

Keep the original packaging of the scanner for safe transportation in case of service, repair and disposal. Unpack and pack your scanner following the instructions.

The Intraoral Scanner is only compatible with Dental Wings handpieces. Make sure you are connected to the internet when plugging a handpiece for the first time.

Reprocessing shall be done before the first use, then after each use, as well as prior to maintenance, service, repair, and disposal to prevent cross-contamination.

Always ensure a biunique relationship between patient, scan and treatment case.

Backup your data at regular intervals. It is the responsibility of the user to perform and maintain data backups in order to prevent loss of data.

Protect your data against loss, unauthorized access and unauthorized use.

Model 001 (cart): Installing additional software may compromise system integrity, slow down performance, and create compatibility issues.

Model 100 (laptop): Install only software validated to be used in combination with the scanner.

Always handle the handpiece with great care as it contains fragile components. Dropping the handpiece and its sleeves on the floor may damage it permanently.

The handpiece heats up over normal body temperature, but it does not pose a hazard to patients due to short term exposure and small contact area.

Always keep a 60 mm distance between eyes and the handpiece.

Make sure the scanner is placed in a safe and stable position.

Never put any load on the scanner.

Make sure to comply with all applicable standards and technical regulations for any computer hardware used. Computer hardware is not intended to be used in close proximity (within a distance of 1.5 meters) to the patient. Do not use extension cords or multiple-socket extension cords to plug the hardware.

Do not dispose of this device as unsorted municipal waste. Collect separately.

2.6 Compatibility information

The device is compatible with the Intraoral Scanner software application version 3.0 and higher.

2.7 Data protection

Access to the software is restricted by the licensing system.

To protect data against loss or unauthorized use, several security mechanisms have been implemented:

- Data encryption during storage and transfer through the internet
- An archiving system to backup patient and planning data
- An on-demand anonymization function for privacy protection

Data managed by the user may require a moderate or high level of protection to ensure privacy and avoid misuse:

- High level: Data with additional statutory requirements in many countries (e.g. patient personal data and medical information)
- Moderate level: Data protected or restricted by contract or other agreement (e.g. license information)

Bear in mind that the user is responsible for data protection on user side. Make sure to adequately protect such data.

⚠ Caution

Protect your data against loss, unauthorized access and unauthorized use.

- Secure your computer system by installing a malware scanner or firewall.
- Use a strong password to protect your computer system, storage media and presentation devices.
- Use data encryption to secure data on your computer system and storage media.
- Backup your data regularly to avoid loss of data.
- Use the anonymization function to protect patient personal data if required.

2.8 Further information

Dental Wings and its products are registered in the main markets. Please be aware that any serious incident that has occurred in relation to the Intraoral Scanner should be reported to your local distributor and the competent authority responsible for medical devices in your country. If you have any questions, please contact your local distributor.

Radiation information

The handpiece contains LEDs. They are rated *Exempt* according to applicable standards (see *Technical data and label, p. 47*).

⚠ Caution

Always keep a 60 mm distance between eyes and the handpiece.

The Intraoral Scanner (cart model) contains a gesture recognition control, which includes an infrared laser projector. It is rated *Class 1* according to applicable standards (see *Technical data and label, p. 47*).

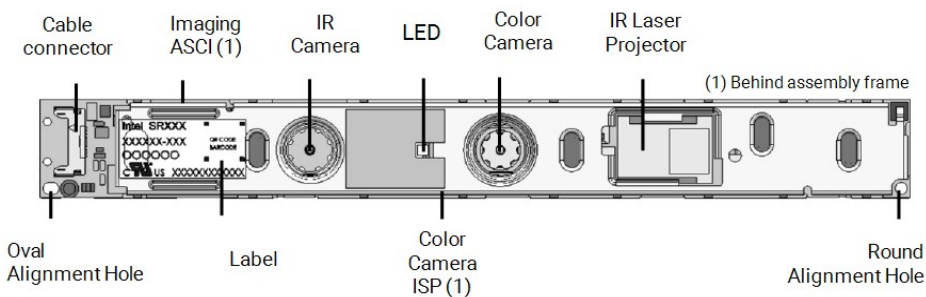

Figure 1: SR300 assembly for gesture recognition module

 Caution

Usage, control, adjustment or execution of the infrared laser projector other than specified below may result in hazardous exposure to radiation.

Usage of the gesture recognition module is specified in *Gesture control - Model 001 (cart) (p. 25)*. The gesture recognition module (SR300) contains an infrared laser projector and shall not be repaired, modified or disassembled. In case of failure, contact your local distributor. Do not try to open any parts of the SR300 assembly. The SR300 does not have any parts that shall be accessed, changed or adjusted by the user. Modification or disassembling of SR300, especially the infrared laser projector, may result in an emission over class I. The manufacturer of the Intraoral Scanner will notice the manufacturer of the SR300 assembly or return the module before conducting any failure analysis.

Electromagnetic compatibility information

The Intraoral Scanner is suitable for use in professional home healthcare environment and does not execute any essential performance function in the understanding of the applied product standards. Nevertheless, it had been tested for electromagnetic compatibility (EMC) and needs special precautions.

The Intraoral Scanner needs to be installed and put into service according to the Electromagnetic Compatibility Guideline (see *Appendix C - Electromagnetic Compatibility Guideline, p. 65*).

 Caution

The use of accessories other than those specified in *Technical data and label* (see *Replacement parts*, p. 52) may result in increased emission or decreased immunity of the Intraoral Scanner.

The Intraoral Scanner allows for wireless network connection. However, it may be interfered with radio frequency (RF) sources in the vicinity of the device (e.g, electromagnetic security systems, cellular telephones, radio frequency identification (RFID) or other in-band transmitters), even if that other equipment complies with the International Special Committee on Radio Interference (CISPR) emission requirements.

Portable and mobile RF communications equipment may affect the performance of Intraoral Scanner. Please avoid strong electromagnetic interference, e.g. nearby mobile phones, microwave ovens during the use of the Intraoral Scanner.

The Intraoral Scanner should not be used adjacent to or stacked with other equipment and that if adjacent or stacked use is necessary, the Intraoral Scanner should be observed to verify normal operation in the configuration in which it will be used.

Other portable radio frequency communications equipment (including peripherals such as antenna cables and external antennas) should be used no closer than 30 cm (12 inches) to any part of the Intraoral Scanner, including cables specified by the manufacturer. Otherwise, degradation of the performance of this device could result.

2.9 Disposal

 Caution

Reprocess prior to disposal to prevent cross-contamination.

Electrical and electronic devices must be disposed of separately from normal household waste in order to promote reuse, recycling and other forms of recovery, to avoid adverse effects on the environment and human health as a result of the presence of hazardous substances in some of their components and to reduce the quantity of waste to be eliminated with a view to reducing landfill. This includes accessories such as remote controls, power cords, etc.



 Caution

Do not dispose of this device as unsorted municipal waste. Collect separately.

For details on how to dispose of your device and its packaging, please contact your local distributor.

3. Installation

⚠ Caution

Keep the original box and packaging material for safe transportation of the device in case of service, repair and disposal. Unpack and pack your scanner following the instructions.

For instructions on how to pack the scanner, see *Packing the scanner* (p. 44).

3.1 Unpacking the scanner

Store the shipping box in a safe place in case you need to transport or ship the scanner in the future.

Model 001 (cart)

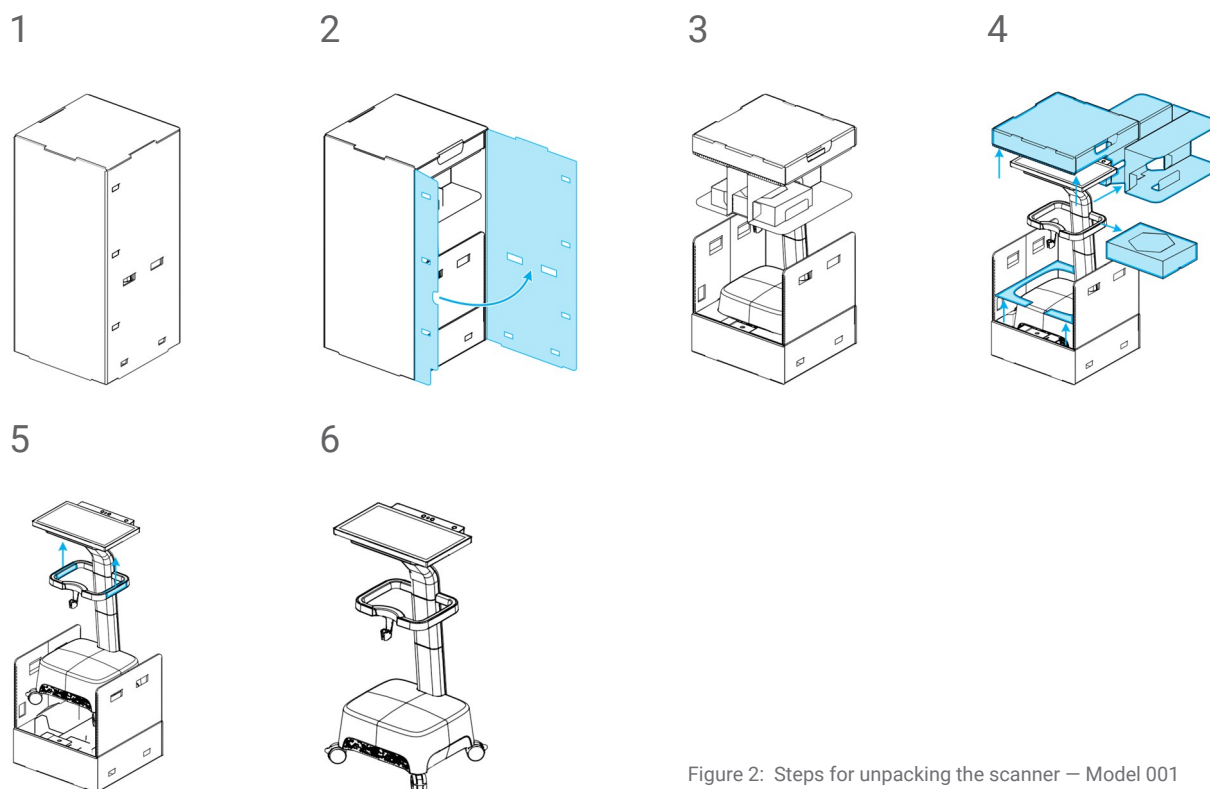

Figure 2: Steps for unpacking the scanner – Model 001

Model 100 (laptop)

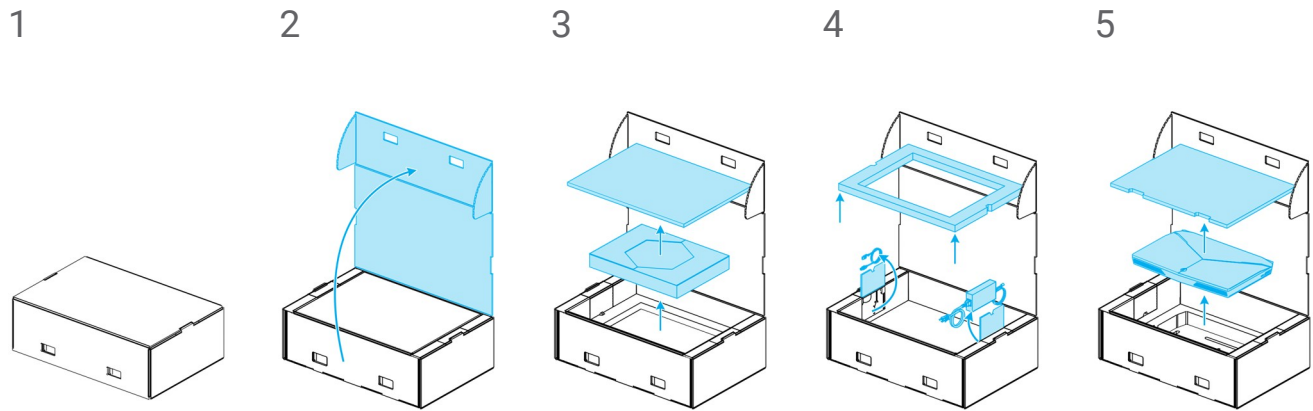

Figure 3: Steps for unpacking the scanner – Model 100

3.2 Setting up the scanner

⚠ Caution

Make sure you have read and understood these instructions for use before installing and operating the scanner. Comply with all precautions and safety information.

Install the scanner in accordance with the manufacturer's instructions.

The scanner is suitable for use in laboratories, dental offices and equivalent environment. However, the protection against dust and water has not been specifically tested. See *Technical data and label, p. 47*.

Do not install the scanner in places with high temperature differences, near heat sources, in direct sunlight or in damp environment (e.g. exposed to splash water). Do not expose this device to rain or moisture. Do not install the scanner in dusty environment.

Do not block any ventilation openings.

Turn off the scanner before plugging or unplugging the power cable.

Always handle the handpiece with great care as it contains fragile components. Dropping the handpiece and its sleeves on the floor may damage it permanently.

The handpiece must be connected to the scanner unit prior to being used on patients.

Parts identification

Model 001 (cart)

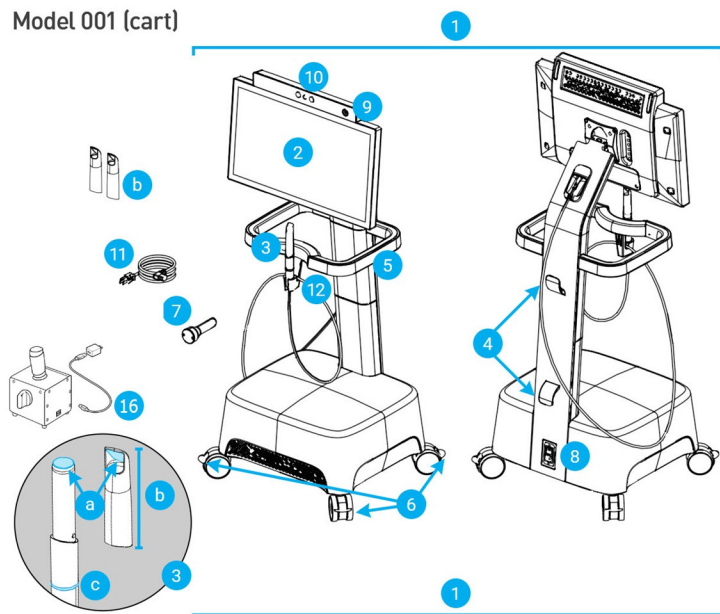

1. Scanner
2. Screen
3. Handpiece
 - a. optics
 - b. sleeve
 - c. light ring
4. Cable hook
5. Handle
6. Wheel lock
7. Integrity-check sleeve
8. Power switch
9. Power button
10. Gesture/voice recognition module
11. Power cord/power supply
12. Holder
13. Handpiece connector power supply
14. USB cable
15. Handpiece connector (with holder)
16. SharpAdjust

Model 100 (laptop)

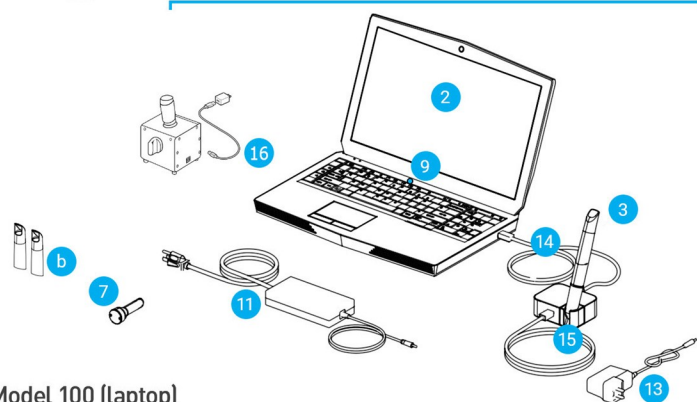

Figure 4: Identification of the scanner parts

Note

The laptop (scanner unit of Model 100) can be replaced by the scanner unit of Model 010 (portable).

Connecting the handpiece

- Plug the handpiece cable into the socket at the back of the screen.

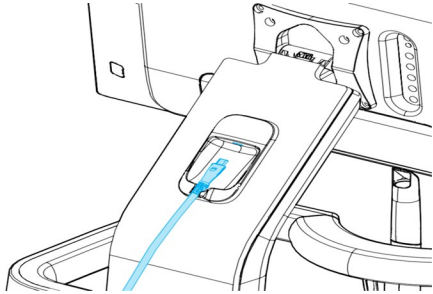

Figure 5: Plugging the handpiece to the back of the screen – Model 001 (cart)

- Plug the end of the handpiece cable into the handpiece connector.
- Plug the handpiece connector via USB into the socket on the laptop.

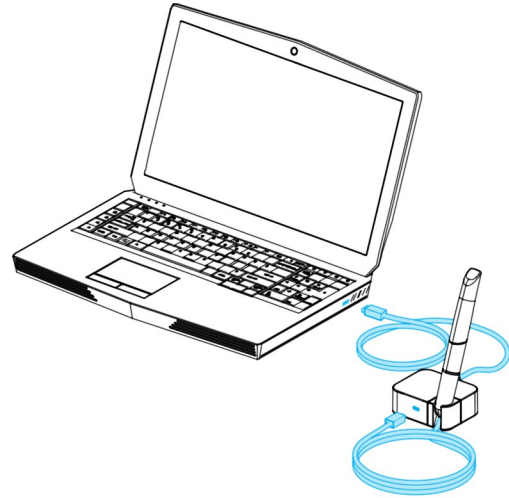

Figure 6: Plugging the handpiece to the handpiece connector – Model 100 (laptop)

⚠ Caution

Make sure that the handpiece/handpiece connector is plugged in the scanner unit before the handpiece comes into contact with patients.

📖 Note

Perform the integrity check to validate installation or when the handpiece is dropped or subject to a shock, to confirm that it still works as specified.

Disconnecting the handpiece

If the scanner unit is shut down, disconnect the handpiece by unplugging the USB from the socket.

If the scanner unit is still on, disconnect handpiece as follows:

1. Select the *Settings* icon of the taskbar, then the *Handpiece Management* submenu.
2. Select the *Disconnect* button.
3. To release the cord, unplug the USB from the socket.

Assembling the handpiece sleeve

Slide the sleeve on the handpiece (without sleeve) and rotate clockwise to lock into position.

Disassembling the handpiece sleeve

Rotate the sleeve counterclockwise to unlock and slide it off the handpiece.

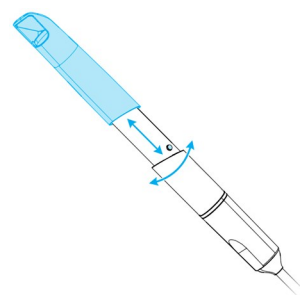

Figure 7: Assembling and disassembling the handpiece sleeve

Caution

Never leave the handpiece elsewhere than in its dedicated handpiece holder.

Plugging the scanner unit

Caution

The Intraoral Scanner (cart model) is a protection class I device. To avoid risk of electric shock it shall only be connected to a power outlet with protective earthing.

Make sure to comply with all applicable standards and technical regulations for any computer hardware used. Computer hardware is not intended to be used in close proximity (within a distance of 1.5 meters) to the patient. Do not use extension cords or multiple-socket extension cords to plug the hardware.

Protect the power cord from being walked on and from pinching.

Model 001 (cart)

1. Plug the power cord in the back of the scanner.
2. Plug the power cord into the power outlet.
3. Flip the power switch in the *power on* position (see *Scanner controls*, p. 22)
4. Press the power button (see *Scanner controls*, p. 22)

Model 100 (laptop)

1. Plug the power cord in the back of the laptop.
2. Plug the power cord into the power outlet.
3. Press the power button (see *Scanner controls*, p. 22)

Refer to instructions for using the device (see *Basic principles and user interface*, p. 22).

Unplugging the scanner unit

Before any maintenance on the scanner, it should be unplugged as follows:

Model 001 (cart)

1. Turn off the device (see *Shutting down the scanner*, p. 24).
2. Flip the power switch in the *power off* position.
3. Unplug the power cord from the power outlet.
4. Loop the cord around the hook(s).

Model 100 (laptop)

1. Turn off the device (see *Shutting down the scanner*, p. 24).
2. Unplug the power cord from the power outlet.

System language

The system language is preset. If this is not the case, contact your local distributor.

4. Basic principles and user interface

Scanner controls

Power switch: used to power on the scanner unit

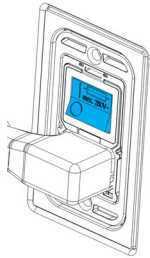

Model 001 (cart)

Position (down)	Scanner status
I	Power on
O	Power off

Power button: used to start up the scanner unit

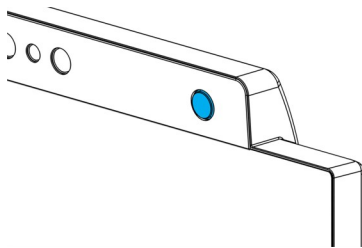

Model 001 (cart)

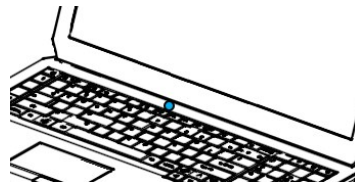

Model 100 (laptop)

Status	Scanner status
Light on	Turned on
Light off	Turned off

Light ring: provides the user with a feedback of handpiece's status

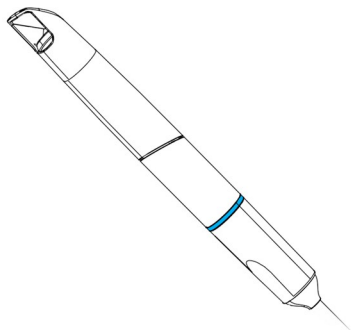

Color	Handpiece status
Blinking, white to blue	Preheating
Blue	Preheated
Green	Scanning & acquiring data
Red	Scanning & not acquiring data

Turning on the scanner

Caution

Turn on the device only with the handpiece fully assembled (with handpiece sleeve).

Model 001 (cart)

1. Press the power switch in the *power on* position.
2. Press the power button.
3. Select your user icon and type in your PIN.

Model 100 (laptop)







1. Press the power button.
2. Select your user icon and type in your PIN.

First use

When the scanner is activated for the first time, a wizard pops up to assist the user with the basic settings: create administrator account, create users, set credentials to local network and other scanner settings.

User interface

The user interface is mainly icon-driven and provides direct instructions for performing the scans. Here are the main stations that you can access from the taskbar that is displayed on the left side of the screen:

- | | | | | | |
|---|---|-------------------------|---|---|------------------------------|
| 1 |  | Change user or shutdown | 4 |  | Case database |
| 2 |  | Workspace | 5 |  | Dentist and patient database |
| 3 |  | | 6 |  | Settings and Options |

Indicates the current workflow status of a case:
Plan, Scan, Align, Review or Export.

Data Transfer (WiFi)

The Intraoral Scanner can be used offline, as a standalone device. It can also be connected to a wireless network to transfer, share, or back up data.

Caution

Use protected WiFi setup and access. Keep a distance to other communication devices of 13 cm when you are using 2.4 GHz and 19 cm when you are using 5 GHz.

Model 001 (cart)

1. Starting outside of the screen, swipe your finger from the left side to the center of the screen.
2. You now have access to the menu of the operating system.
3. Follow operating system instructions to connect to wireless networks.

Model 100 (laptop)

Follow operating system instructions to connect to wireless networks.

Shutting down the scanner

Caution

Wait until the scanner is completely shut down before unplugging the power cord.

Model 001 (cart)







1. Click the top icon on the taskbar.
2. Select *Shutdown*.
3. Confirm (a warning pops up if a case is uploading to DWOS Connect).
4. Flip the power switch in the *power off* position if the power cord needs to be unplugged.

Model 100 (laptop)

Follow shutdown instructions for your operating system.

Gesture control - Model 001 (cart)

The cart model is equipped with a gesture recognition module. It works with an infrared laser sensor [for safety information, refer to *Further information* (p. 11)] which is located above the screen as shown on *Figure 4: Identification of the scanner parts* (p. 17). Using gesture control instead of the touch-screen prevents cross-contamination during scanning.

Step	Hand gesture		Triggered action
1	Place hand wide open in front of the sensor.		Activates the gesture control feature.
2	Point one finger upwards.		Displays contextual menu.
3	Move hand wide open from side to side.		To navigate inside the contextual menu.
4	Point one finger upwards.		Stops the navigation. You can therefore move your hand without affecting the selection.
5	Move hand towards the sensor while the finger is still pointing upwards.		Enters the selection.
6	Move hand wide open in any direction.		Moves the scan in 3D as if it was linked to your hand.

Voice control - Model 001 (cart)

The cart model is equipped with a voice recognition module. It works with a microphone which is located as shown on *Figure 4: Identification of the scanner parts* (p. 17). Using voice control instead of the touch-screen prevents cross-contamination, and lets you scan without moving your hands away from the patient or handpiece. The commands are listed below with their associated action.

Voice command	Triggered action
io start	Launches the scan for the current element (upper, lower or occlusion).

io pause	Pauses the current scan (re-launch with the start command).
io next	Switches to the next step.
io reset	Erases current data.
io undo	Removes surface data in a chronological fashion.
io redo	Restores surface data in a chronological fashion.
io lock	Protects the current scan against modification. The locked surfaces turn into a reddish color.
io unlock	Releases the locked surfaces so that they can again be modified. They turn back into their original color.
io screenshot	Takes a screenshot of the current view and attaches it to the order.
io take photo	Within the <i>Add Picture</i> feature of the <i>Plan Editor</i> : takes a photo from the screen built-in camera or from the handpiece camera, according to which one is active.
io detect	Detects the scanbody when the handpiece is pointing at it during scanning.

5. Scanning

5.1 Accuracy

This scanner performs highly accurate scans. For scanning accuracy as measured according to Dental Wings testing standard, see *Integrity check* (p. 35).

 Caution

To achieve scanning accuracy, comply with all given instructions.

Considering that the final accuracy and fit of the restoration highly depend upon the preciseness of the user's manipulations and judgment, the clinical outcome is easily influenced by the following factors ¹:

- Scanning too fast
- Jaws shifting during occlusion scan
- Inadequate occlusion alignment

5.2 Step-by-step

Setup

 Caution

Make sure the scanner has been reprocessed as described in *Reprocessing* (p. 32).

¹ Certain error sources can contribute with deviations in mm range.

- Select a User or a Dentist.
- Enter security PIN.
- Select *New case*.
- Enter case description, including tooth number, restoration type, material and shade.
- Set *Appointment Date* for the preparation.
- Set *Due Date*, as the target delivery for the restoration at your clinic.
- Specify if a *Pre-Preparation Scan* is desired.
- Select *Patient* (create or search).
- Add notes and attach files as desired.
- Select *Next*.

Preheat the handpiece prior to scanning. When the light ring turns red or green, the handpiece is ready for scanning.

 **Caution**

Always ensure a biunique relationship between patient, scan and treatment case.

Scan

 **Caution**

Scan the area of interest until sufficient data is collected.

The handpiece heats up over normal body temperature, but it does not pose a hazard to patients due to short term exposure and small contact area. See *Temperature limits*, p. 47.

- Prepare for scanning in the same way as necessary for taking a physical impression. The area to be scanned shall be dry (e.g. no bleeding, no ulcers).
- Lift the handpiece from its holder.
- Remove protective packaging from the handpiece, if any.
- For re-scanning the area of interest, scan upper and lower arches as well as bite, following on-screen instructions.
- Select *Next* after each arch.
- Replace the handpiece on its holder.

For further details regarding scanning techniques, visit our website.

Alignment

Caution

Verify that upper and lower arches are identified as such.

- Align upper and lower scans onto the bite scan, following on-screen instructions.
- If needed, invert upper and lower arches by selecting *Swap Arches*.
- If needed, switch quadrant by selecting *Switch Sides*.
- Adequate superimposition can be observed when the surface presents an evenly marbled pattern between both colors. Confirm by selecting *Next*.

Review

- Confirm complete occlusion by observing sufficient red areas.
- Identify planned preparations on the scanning data.
- Confirm adequate occlusal spacing on each preparation for restoration material using the gradient slider.
- Confirm absence of undercuts on each preparation by simulating the insertion axis.
- If desired, specify part or complete margin line on each preparation.

Export to DWOS Connect

- In the *Export* screen, verify the case overview.
- Select collaborating laboratory from the drop-down list.
- Review or complete attachments and notes.
- Select *Export*.

Back to the home screen, a progress bar is displayed until the case is sent. Wait until the progress is completed before turning off the device.

Export to STL

- Click the *Case database* icon from the taskbar.
- On the case to export, swipe your fingers towards the right side of the screen.
- Select *Export STL*.
- Select the destination folder.

6. Maintenance

6.1 Handling

Store handpiece, scanner unit, and SharpAdjust according to the specified ambient conditions (see *Ambient conditions, p. 49*).

Use standard packaging material to protect the handpiece and accessories from contamination between uses (see *Accessories and products used in combination, p. 7*).

Unplug the device during lightning storms or when unused for long periods of time.

When not in use, SharpAdjust shall always have the sleeve cap on, and be kept in the original packaging.

Note

The product warranty does not apply if damage to the product is the result of a lightning strike.

Caution

Never put any load on the scanner.

Make sure the scanner is placed in a safe and stable position.

The surface the scanner is placed on shall be intended to carry the weight.

Always lock the wheels when not moving the cart model. Push down the tabs for locking the wheels.

Before any maintenance action, unplug and reprocess the scanner.

To reduce the risk of electric shock, do not remove the cover. Refer servicing to qualified service personnel.

Protect the handpiece from contamination between uses.

Ensure that the packaging is large enough to contain the handpiece without excessively bending the cable.

Model 001 (cart): Installing additional software may compromise system integrity, slow down performance, and create compatibility issues.

Model 100 (laptop): Install only software validated to be used in combination with the scanner.

Moving the scanner to another room

Model 001 (cart)

- Shut down according to instructions (see *Shutting down the scanner*, p. 24)
- Flip the power switch in the *power off* position.
- Unplug the cord from the power outlet and loop it around the hook(s).
- Unlock the wheels by lifting up the red tab on each one of them.
- Move the device while holding it by the handle (see *Identification of the scanner parts*, p. 17).
- When arrived at destination lock each wheel by pushing down the tab.

Model 100 (laptop)

- Shut down according to instructions (see *Shutting down the scanner*, p. 24)
- Unplug the power cord from the outlet.
You can now move the laptop to a new location.

Note

If the handpiece is dropped or subject to a shock, run the integrity check to confirm that it still works as specified. See *Integrity check*, p. 35.

Transportation

Always use the original packaging to transport the scanner. Refer to instructions for *Packing the scanner* (p. 44) and *Unpacking the scanner* (p. 15).

6.2 Reprocessing

Reprocessing means the processing of re-usable medical devices. Reprocessing is specified in Appendix A and B and consists of all or some of the following:

- preparation at the point of use;
- preparation, cleaning, disinfection;
- drying;
- inspection, maintenance and testing;
- packaging;
- sterilization;
- storage.

⚠ Warning

Reprocessing shall be done before the first use, then after each use, as well as prior to maintenance, service, repair, and disposal to prevent cross-contamination.

⚠ Caution

Before any reprocessing, unplug the scanner and SharpAdjust from power outlet.

Always handle the handpiece with great care as it contains fragile components. Dropping the handpiece and its sleeves on the floor may damage it permanently.

After disinfection, before sterilization, make sure the optical system is cleaned as follows:

1. Disassemble the handpiece sleeve (see *Assembling and disassembling the handpiece sleeve, p. 19*).
2. Clean the optics on the handpiece sleeve using a foam tip applicator soaked with alcohol (see *Figure 8: Cleaning the optics of handpiece and sleeve, p. 33*).
3. Clean the optics on the handpiece (without sleeve) using a foam tip applicator soaked with alcohol (see *Figure 8: Cleaning the optics of handpiece and sleeve, p. 33*).

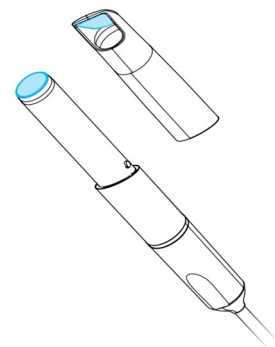

Figure 8: Cleaning the optics of handpiece and sleeve

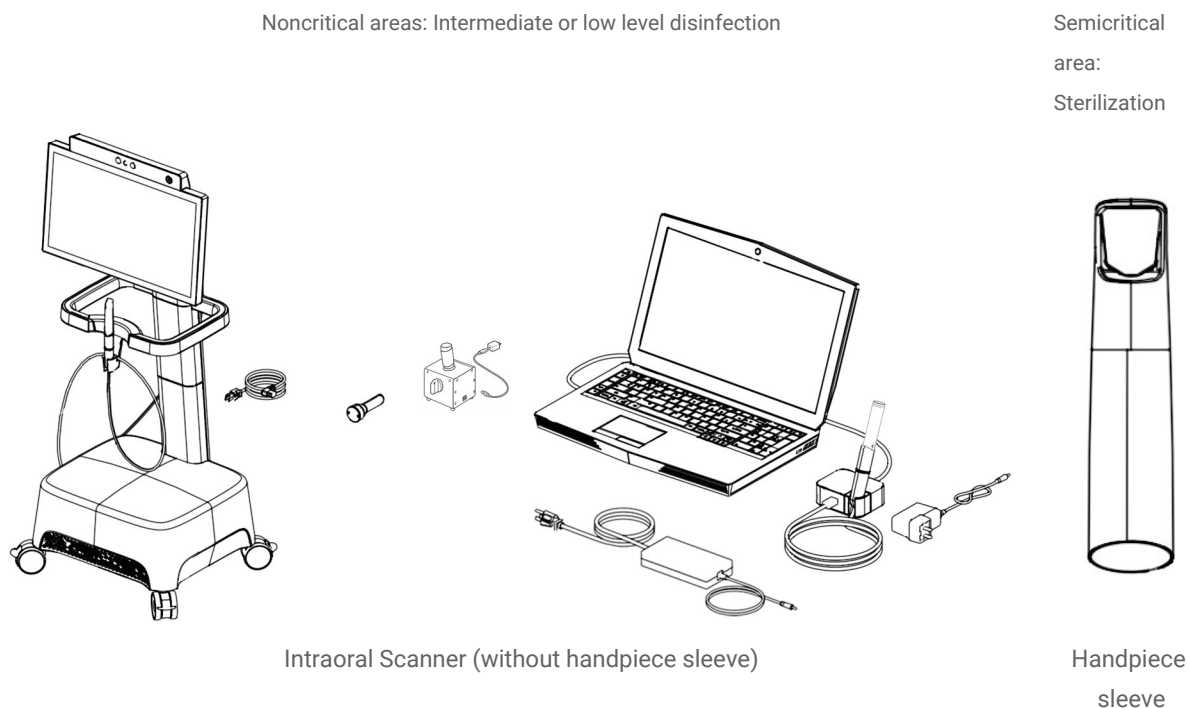

Figure 9: Disinfection levels of handpiece sleeve/scanner

The Intraoral Scanner consists of semicritical and noncritical areas. The materials used in the semicritical area are biocompatible. The semicritical area requires sterilization. The noncritical areas require intermediate or low level disinfection.

Appendix A - Reprocessing of the handpiece sleeve and Appendix B - Reprocessing of the Intraoral Scanner (without handpiece sleeve) contain further details on how to reprocess the device.

The instructions given have been validated by Dental Wings as being capable of preparing the Intraoral Scanner for re-use. It remains the responsibility of the user to ensure that the reprocessing as actually performed using equipment, material and personnel in the dental or reprocessing facility achieves the desired result. This requires validation and routine monitoring of the process. Likewise, any deviation by the user from the instructions provided is performed under sole responsibility of the user and should be properly evaluated for effectiveness and potential adverse consequences.

6.3 Data backup

Caution

Backup your data at regular intervals. It is the responsibility of the user to perform and maintain data backups in order to prevent loss of data.

The Intraoral Scanner performs automatic backups of the database, as long as you define a destination for it:

1. Log in as *Administrator*.
2. Select the *Settings* icon from the taskbar, then the *System Settings* submenu.
3. In the field *Backup target directory*, type in a location or click the folder icon to browse to the desired destination for storing the files created by the automatic backup feature.

6.4 Maintenance tools

The Intraoral Scanner is a self-maintenance device. There are two maintenance tools available:

- The integrity-check sleeve is a non-medical, non-electrical component delivered with all models of the Intraoral Scanner.
- SharpAdjust is a non-medical, electrical component of the Intraoral Scanner, with its own label. SharpAdjust is delivered to users upon request.

Users are prompted by the software to periodically apply the integrity-check sleeve to validate the integrity of the optical system. If the integrity cannot be validated, users are guided to run SharpAdjust to fine-tune the optical system.

Integrity check

The integrity-check sleeve is a maintenance tool used to validate the integrity of the optical system of the scanner.

Caution

Make sure the integrity-check sleeve is reprocessed as required before and after use. See *Appendix B - Reprocessing of the Intraoral Scanner (without handpiece sleeve)*, p. 61.

1. Make sure the handpiece (without sleeve) is connected to the scanner unit (see *Disassembling the handpiece sleeve*, p. 19).
2. Select the *Settings* icon of the taskbar, then *Handpiece Management* submenu.
3. Slide the integrity-check sleeve on the handpiece and rotate clockwise to lock into position (see *Figure 10: Using the integrity-check sleeve*, p. 36).
4. Select the *Start test* button and wait for confirmation and further instructions to display on the screen.
5. When the process is over, rotate the integrity-check sleeve counterclockwise to unlock and slide it off the handpiece.

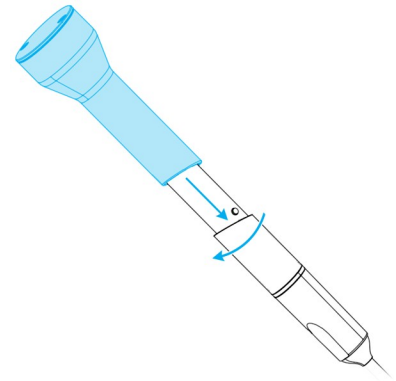

Figure 10: Using the integrity-check sleeve

Note

The scanner does not require calibration. However, the integrity check should also be performed if the handpiece sleeve is dropped or subject to a shock, to confirm that it still works as specified.

SharpAdjust

SharpAdjust is a maintenance tool used to fine-tune the optical system of the Intraoral Scanner. It is applied in case the integrity check is unsuccessful two times in a row.

Caution

Make sure SharpAdjust is reprocessed as required before and after use. See *Appendix B - Reprocessing of the Intraoral Scanner (without handpiece sleeve)*, p. 61.

When SharpAdjust is not in use, store it with the sleeve cap on, in the original packaging.

Parts identification

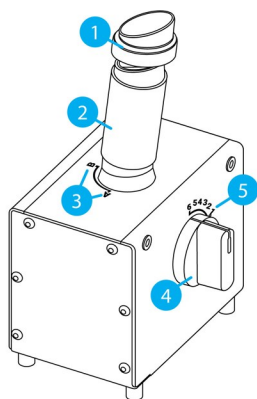

1. Cap
2. SharpAdjust sleeve
3. SharpAdjust sleeve positions
4. Dial switch
5. Switch positions

Figure 11: Identification of SharpAdjust parts

Connecting SharpAdjust

SharpAdjust is connected and ready to use if the light is on. If SharpAdjust is not working properly, contact your local distributor.

Model 001 (cart)

1. Plug the USB cable into SharpAdjust.
2. Plug the other end of the cable into a power outlet using a USB power supply.
3. Remove the cap from the SharpAdjust sleeve.

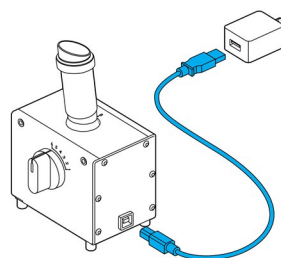

Figure 12: Plugging SharpAdjust for Model 001 (cart)

Model 100 (laptop)

1. Plug the USB cable into SharpAdjust.
2. Plug the other end of the cable into the laptop USB port.
3. Remove the cap from the SharpAdjust sleeve.

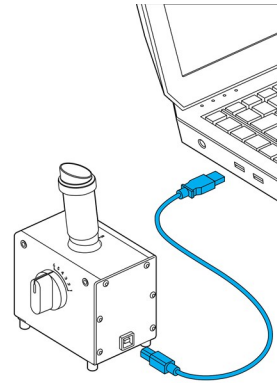

Figure 13: Plugging SharpAdjust for Model 100 (laptop)

Running SharpAdjust

1. Connect SharpAdjust to power outlet (see *Connecting SharpAdjust*, p. 37).
2. Make sure the handpiece (without sleeve) is connected to the scanner unit (see *Disassembling the handpiece sleeve*, p. 19).
3. Slide the handpiece into the SharpAdjust sleeve and rotate clockwise to lock into position.
4. Set SharpAdjust sleeve to position A and turn the dial switch to 1.
5. Launch SharpAdjust in Settings > Handpiece Management. Follow on-screen instructions.
6. When the process is complete, rotate the handpiece counterclockwise to unlock and slide it out of the sleeve.

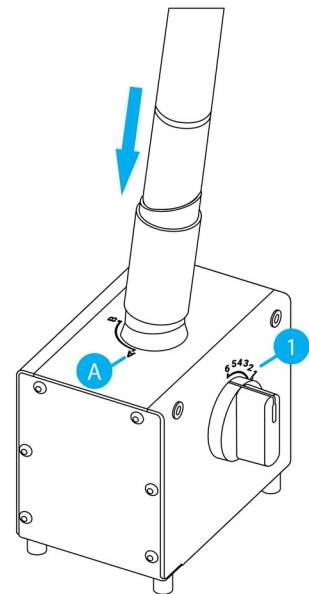

Figure 14: Using SharpAdjust to fine-tune the handpiece optical system

Disconnecting SharpAdjust

1. Make sure that the handpiece is removed from SharpAdjust.
2. Unplug SharpAdjust.
3. Reprocess as described in *Reprocessing* (p. 32).
4. Put the cap back on the SharpAdjust sleeve and store the tool in its original packaging.

6.5 Changing fine fuses

Model 001 (cart)

Model 001 (cart) of the Intraoral Scanner contains two fine fuses (see *Technical data and label*, p. 47). They are located at the back of the scanner unit, inside the power switch assembly (see *Figure 4: Identification of the scanner parts*, p. 17). If necessary, exchange them in the following way:

1. Using a small flathead screwdriver (approx. width 4 mm), lever out the insert.
2. Change the corresponding fine fuses.
3. Reassemble.

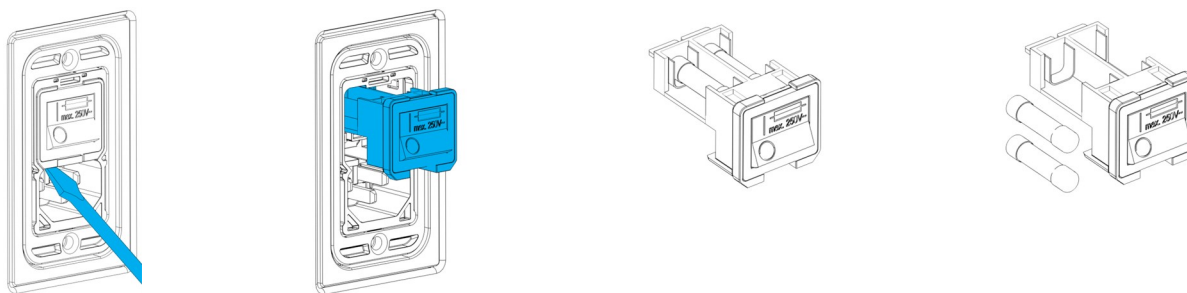

Figure 15: Instructions for changing fine fuses - Model 001 (cart)

6.6 Service

⚠ Caution

Reprocess prior to service to prevent cross-contamination.

To reduce the risk of electric shock, do not remove the cover. Refer servicing to authorized service personnel.

Do not replace components of the scanner without the prior authorization from your distributor. Refer servicing to authorized service personnel.

Servicing is required when the device has been damaged in any way, has been exposed to rain or moisture, does not operate normally, or has been dropped. Contact your local distributor.

The Intraoral Scanner does not require regular service. However, in certain countries it might be mandatory according to national law. A risked based approach taking into account the amount of usage is acceptable. It shall be conducted according IEC 62353.

When returning your scanner for service or repair, pack the scanner as described in *Packing the scanner* (p. 44).

7. Troubleshooting

Find below a list of messages (some are abbreviated) that could appear while using the Intraoral Scanner, and the actions that should be taken to solve the problem.

On-screen message	Required action
Start up and log in	
Cannot start setup	Restart the device and try again.
Credentials could not be verified.	
It seems that there is no valid license to run this software on your system	Contact your local distributor to obtain a license.
The scanner initialization failed	Ensure that the handpiece is properly connected and restart the device.
Hardware and configuration	
Integrity check unsuccessful	Follow on-screen instructions or contact your local distributor.
SharpAdjust unsuccessful	
Integrity check failed because of an unforeseen error...	Restart the device and try again.
An error has occurred.	
No configuration file found for the connected handpiece.	<ol style="list-style-type: none"> 1. Check internet connection. 2. Click the <i>Settings</i> icon from the taskbar and select <i>Handpiece Management</i> submenu. In the Overview section, click on the download icon.
The configuration file does not match the connected handpiece.	
The connected handpiece has been qualified for demonstration only, not for clinical use.	The scan accuracy of the connected handpiece is not sufficient for patient cases.

On-screen message	Required action
Database	
Case creation failed.	
... could not be computed/imported...	
Unable to save...	Restart the device and try again.
Patient/Dentist update/deletion failed.	
Database backup execution failed.	Try to export in a different folder and/or a different file name.
Implant kit / ipflib file errors.	Select a valid implant kit file.
Software	
Server errors.	
Error... loading 3D graphic resource.	
Unable to save the recorded message.	
Cannot recognize microphone.	Restart the device and try again.
An error occurred while recording.	
Failed to convert case to XOrder...	
Dentist assignment failed.	
Wrong client version.	Run the updater again.
Case export failed.	Try to export in a different folder and/or a different file name.
Scanning	
Scanned area too small for meshing.	Scan more tooth surface before proceeding.
Unable to create mesh from scanned points.	Clear scan data and rescan.
Could not swap arches...	
... Failed to create a temporary directory...	Clean up hard drive.
This case is not ready to export.	Complete the scan workflow before exporting the case.

On-screen message	Required action
No scan to save.	Complete the scan procedure and retry.
The scan has been interrupted to prevent overheating...	Wait one minute to let the handpiece cool down and then resume scanning.
DWOS Connect	
No internet connection...	Check internet connection.
Server not found/not reachable...	
Authentication to DWOS Connect failed.	Try again later.
Failed to authenticate on DWOS Connect...	Check DWOS Connect credentials.
Bad configuration for remote server.	Check that the DWOS Connect configurations are valid.
No remote server is configured.	Configure your case exchange server connection.
This case is not in queue.	Check if the case is in the upload queue in the workspace screen. If yes, restart the device and try again.
This case is already in queue.	Check if the case is in the upload queue in the workspace screen. If not, restart the device and try again.
Upload was canceled.	If you did not cancel the upload on purpose, restart the device and try again.
Please select a supplier...	Select a supplier in the export screen and export the case again.
Failed to upload case... Will automatically retry later.	Wait until it automatically retries. If it still fails, restart the device and try again.
Concurrent upload/multiple DWOS connect configurations not supported yet.	Contact your local distributor.
Internal server error (no token).	
A case cannot be exported twice.	Delete the case in DWOS Connect web interface and try again.
DWOS Connect configuration mismatch...	Use DWOS Connect web interface to delete the case.

If the recommended action does not solve the problem, or for other on-screen messages, contact your local distributor.

8. Packing the scanner

Model 001 (cart)

Packing the scanner for transportation must be done as follows:

- Shut down the scanner unit.
- Flip the power switch in the *power off* position.
- Unplug the power cord, wind it carefully and place it inside one of the packaging inserts.
- Place the handpiece in its case.
- Pack the scanner in its original box and packaging material as shown below.

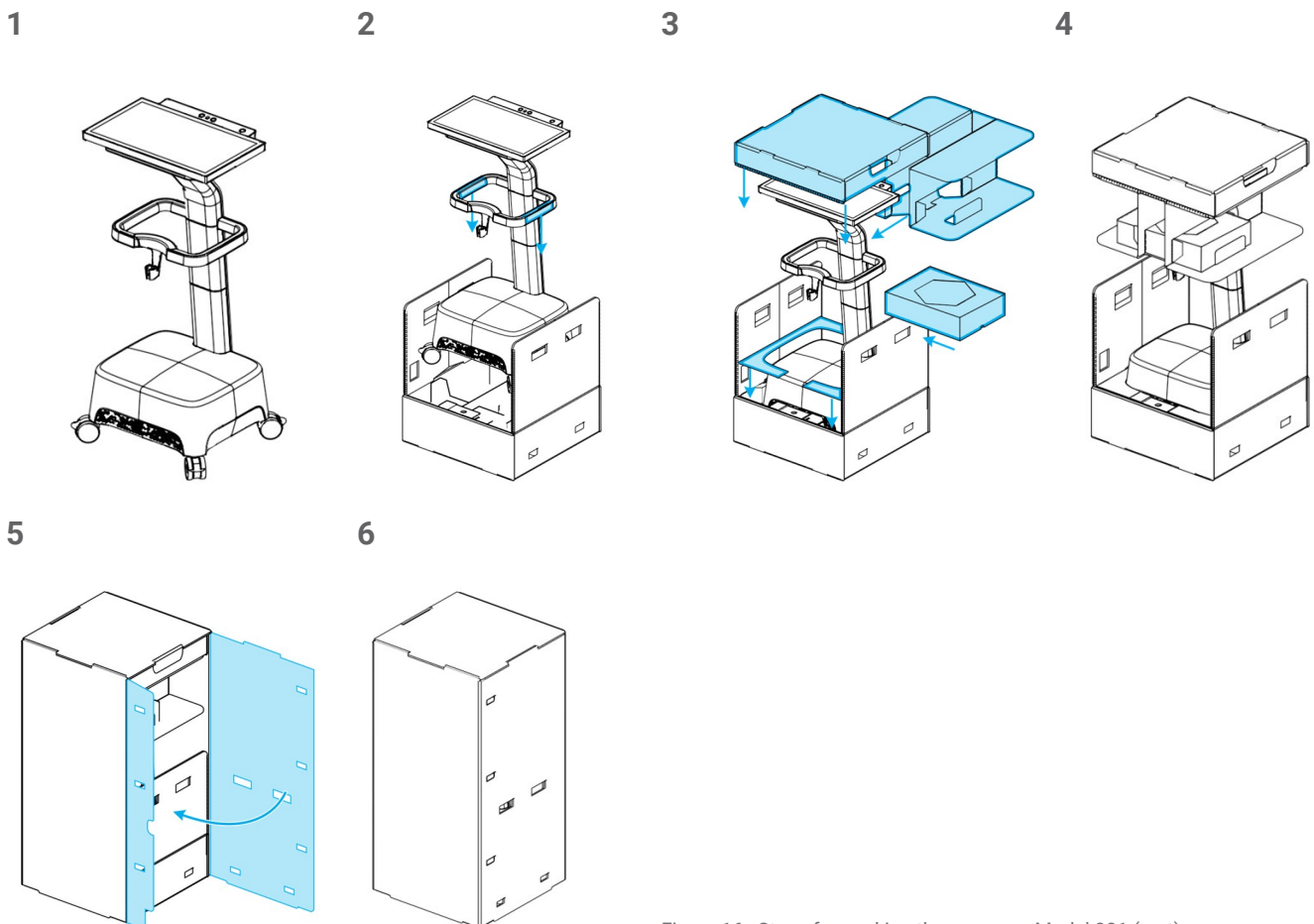

Figure 16: Steps for packing the scanner - Model 001 (cart)

Model 100 (laptop)

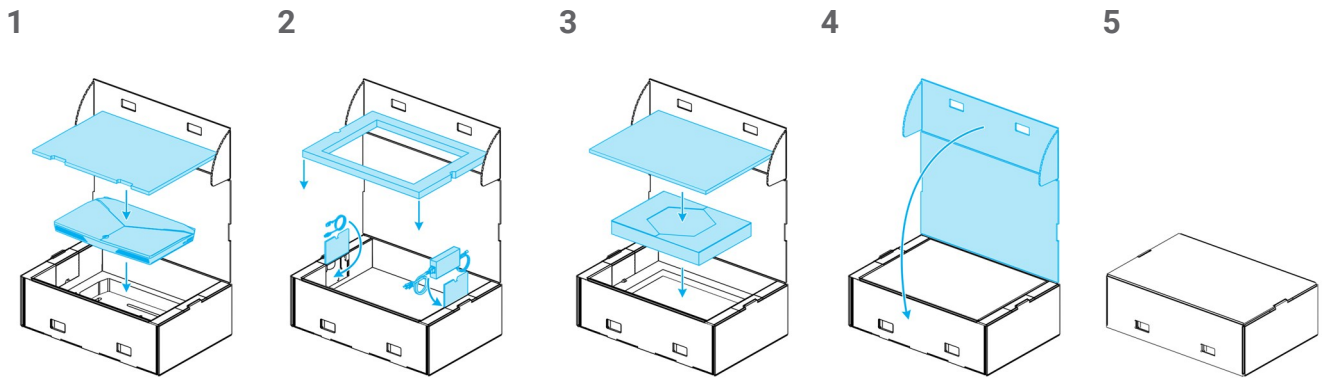

Figure 17: Steps for packing the scanner - Model 100 (laptop)

9. Distributors and service

Refer servicing to authorized service personnel. In case of questions or repair, please contact your local distributor.

Alternatively, contact support@dental-wings.com (in English, French or German).

10. Technical data and label

Technical data			
Type/Model		DW-IO-001 (cart)	DW-IO-100 (laptop)
Scanner unit input		100 - 240 V ~, 50 Hz - 60 Hz, 540 VA	100 - 240 V~, 50 - 60 Hz, 72 VA Handpiece Connector input: 5 V $\overline{\text{DC}}$, 15 W
Fuse		5 mm x 20 mm, medium speed, 6 A, ceramic (high breaking capacity), 250 V ~ (2 x M6AH250V)	no fuse
Transceiver Module	Frequency	N/A	60.48 GHz
	Type of modulation	N/A	On-Off Keying (OOK)
	Effective radiated power output	N/A	0.0014 W
WiFi	Frequency	2.4 GHz or 5 GHz	
	Standards	IEEE 802.11g/n/ac	
	Security	Protected Access (WPA2) Protected Setup (PIN & PBC)	
	Effective Radiated Power Output	0.085 W for IEEE 802.11 n/ac (dual band) 5 GHz 0.353 W for IEEE 802.11 g/n (single band) 2.4 GHz	
Handpiece	Temperature limits	40°C - 48°C (104°F - 118°F)	
	Weight	approx. 130 g (approx. 0.29 lbs)	
	Dimensions (\varnothing at tip x L)	20 mm x 207 mm (0.8" x 8.1")	
	Type (acc. IEC 60601-1)	Applied part type BF	

Technical data		
Type/Model	DW-IO-001 (cart)	DW-IO-100 (laptop)
LED risk group (acc. IEC 62471)	Exempt ¹	
Laser class (acc. IEC 60825)	Class 1	no laser
Protection class (acc: IEC 60529)	IPX0 (noncritical area - no protection)	
Protection class (electrical)	Class 1 Equipment; Basic insulation, relies on an earth for protection. The earth connection is achieved with a 3-conductor mains cable ending in a 3-prong AC connector which shall be plugged into a corresponding AC outlet.	Class 2 Equipment: Double insulated electrical equipment which does not require a safety connection to earth for protection.
Pollution Degree	2; Normally only non-conductive pollution occurs. Temporary conductivity caused by condensation is to be expected.	
Mode of operation	Continuous	
Computer / operating system	Integrated high-performance computer storage for 8000 cases Dedicated high-end graphic card Windows 10 operating system Integrated gesture and voice recognition modules	Minimum requirements ² Memory: 16 GB DDR4 at 2400 MHz Processor: Intel® Core™ i7-8750H Graphic card: NVIDIA GeForce GTX 1060 with 6 GB GDDR5 Hard disk: 256 GB SSD
	21" multi-touch screen	17" screen
Dimensions uncrated (L x W x H)	520 mm x 460 mm x 1270 mm (20.5" x 18.1" x 50.0")	422 mm x 321 mm x 31 mm (16.6" x 12.6" x 1.2")
Dimensions crated (L x W x H)	600 mm x 510 mm x 1370 mm (23.6" x 20.1" x 53.9")	613 mm x 409 mm x 216 mm (24.1" x 16.1" x 8.5")
Weight uncrated	38.0 kg (84 lb)	5.9 kg (13.0 lbs)
Weight crated	54 kg (119 lb)	9.2 kg (20.2 lbs)

¹ Handpiece with handpiece sleeve measured in worst case scenario (60 mm distance).

² Minimum requirements have been specified to allow for smooth operation of the software. The software might also run on configurations with higher performance. The suitability of such configurations has to be validated by the user.

Technical data	
Type/Model	SharpAdjust
Input	5V $\overline{\text{DC}}$, 150 mA
LED risk group (acc. IEC 62471)	Exempt
Protection class (acc: IEC 60529)	IPX0 (noncritical area - no protection)
Protection class (electrical)	Class 3 equipment, designed to be supplied from a separated extra-low voltage (SELV) power source. The voltage from a SELV supply is low enough that under normal conditions a person can safely come into contact with it without risk of electrical shock.
Pollution Degree	2; Normally only non-conductive pollution occurs. Temporary conductivity caused by condensation is to be expected.
Mode of operation	Continuous
Power source	Mandatory requirements: SharpAdjust is powered via USB cable. A separate USB power supply containing the safety markings required by national regulation can be used, as well as a USB port on a laptop or personal computer.
Dimensions uncrated (L x W x H)	112 mm x 94 mm x 169 mm (4.4" x 3.7" x 6.7")
Dimensions crated (L x W x H)	241 mm x 190 mm x 160 mm (9.5" x 7.5" x 6.3")
Weight uncrated	800 g
Weight crated	1230 g

Ambient conditions	
Operating temperature	15°C - 30°C (59°F - 86°F)
Storage conditions	10 °C - 40°C (50°F - 104°F), controlled moisture (no condensation)
Transportation temperature	-62°C - 71°C (-80°F - 160°F)
Relative humidity	20% - 80%
Atmospheric pressure	60 kPa - 106 kPa

Software applications	Included	Optional
Intraoral Scanner software application	x	

Scanning parameters	
Patient characteristics	No restrictions apply
Optical technology	LED light High-speed measuring cameras Video cameras
Scanning accuracy/time	According to Dental Wings testing standard. For further details contact your local distributor (see <i>Distributors and service</i> , p. 46).
Output format	Open STL or cloud sharing through DWOS Connect

Scanner labels

This is an example of the label on your device:

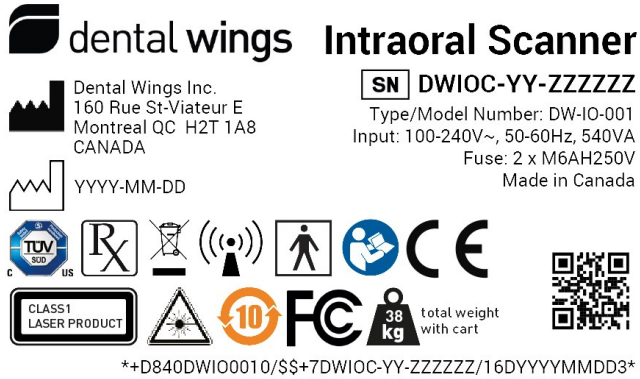

Figure 18: Device label – Model 001

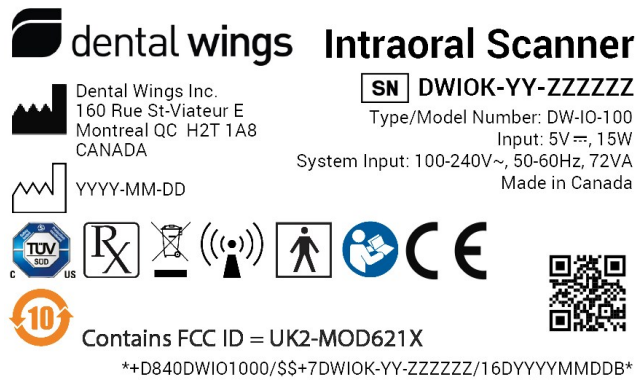

Figure 19: Device label – Model 100 (bright background)

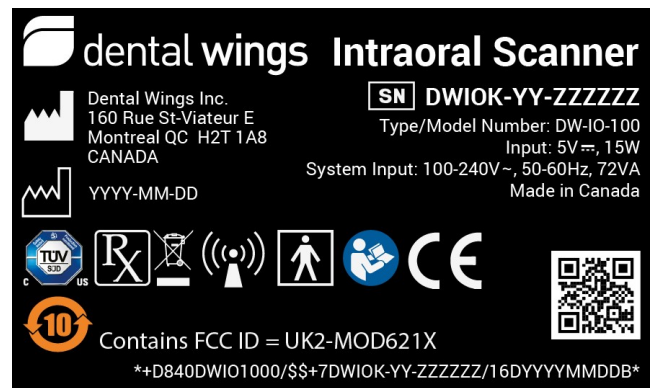

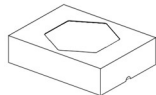



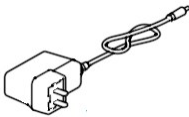

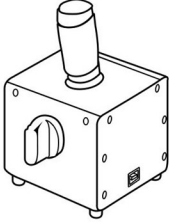
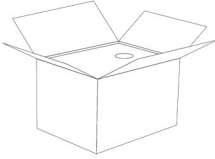
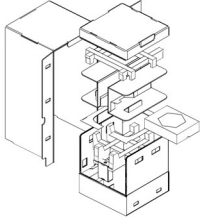
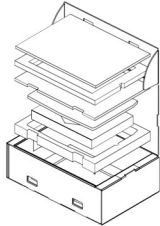

Figure 20: Device label – Model 100 (dark background)

Replacement parts	Model 001	Model 100	Part No.	Image	Intended use
Handpiece	●	●	6100-1 (Connection cable length 2.54 m)		Replacement or additional handpiece for the Intraoral Scanner.
Handpiece Storage Case	●	●	70-0045		Protects the handpiece and accessories during shipment and storage.
Handpiece Sleeve	●	●	6190-1		Replacement or additional handpiece sleeve for the Intraoral Scanner.
Handpiece Sleeve Storage Case	●	●	70-0095		Protects handpiece sleeves during shipment and storage.
Power Cord	●		22-0156 (US, CN: Length 2.5 m) 22-0159 (EU) 22-0165 (UK) 22-0167 (BR)		The country-specific power cord connects the Intraoral Scanner to power outlet.
Handpiece Connector Power Supply		●	21-0200 (US, EU, UK, AU)		The country-specific power supply connects the Intraoral Scanner to the power outlet.
Integrity-check Sleeve	●	●	6191-1		The integrity-check sleeve is a maintenance tool used to validate the integrity of the optical system of the Intraoral Scanner.

Replacement parts	Model 001	Model 100	Part No.	Image	Intended use
SharpAdjust	●	●	6195-1		The SharpAdjust is a maintenance tool used to fine-tune the optical system of the Intraoral Scanner.
SharpAdjust Storage Case	●	●	6195-2		Protects SharpAdjust during shipment and storage.
Client Shipping Crate	●		6092-1		This box serves as (replacement) box for return shipment.
Client Shipping Box		●	6392-1		This box serves as (replacement) box for return shipment.

11. Explanation of symbols



Indicates the device's legal manufacturer



Indicates the date when the device was manufactured



Indicates the serial number of the device



Caution, consult Instructions for Use for important cautionary information.



Laser radiation



Class 1 laser product acc. to IEC 60825-1



Direct current



Alternating current



Device fulfills the requirements of the European directives given on the EU Declaration of Conformity.



Compliance with U.S. Occupational Safety and Health standards as well as SCC requirements (Canada)



Device complies with part 15 of the FCC rules.



Environment friendly use period acc. to China RoHS



Caution: US Federal law restricts this device to sale by or on the order of a licensed health-care practitioner.



Contents of the transport package are fragile. Handle with care.



Indicates the correct upright position of the transport package



Do not dispose of this device as unsorted municipal waste. Collect separately.



Follow Instructions for Use



Device includes a radio frequency transmitter; interference may occur in the vicinity of equipment marked with this symbol.



Type BF Applied Part



Device weight is as indicated in the label, no working load permitted.



Temperature limit for transport



Humidity limitation

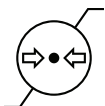

Atmospheric pressure limitation

Please note that the above symbols may appear with inverted colors (e.g. on the nameplate).

Appendix A - Reprocessing of the handpiece sleeve

Manufacturer: Dental Wings Inc.

Method: Sterilization and intermediate or low level disinfection

Device: Intraoral Scanner handpiece sleeve

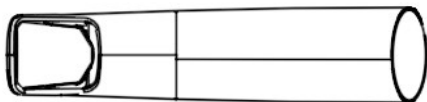

Figure 21: Handpiece sleeve

Precautions

- Do not use abrasive cleaners.
- Scratches on the optics cause damage to the handpiece sleeve. Be very careful in applying the soft, nylon-bristled toothbrush. Do not rub cloth against optics. Use a blotting motion.
- Protect personnel and surroundings from contamination while brushing.
- Do not use corrosive cleaning agents or disinfectants with acids, bases, oxidizing agents, and solvents (with exception of simple alcohol).
- Make sure the handpiece sleeve is completely dry before packing.
- Corroded and rusty handpiece sleeves can contaminate the water circuit of the washer/disinfector with rust particles. These rust particles will cause initial rust on intact parts.
- Regularly inspect and clean the equipment used.
- When sterilizing multiple handpiece sleeves in one steam sterilizer cycle ensure that the sterilizer's maximum load is not exceeded.

Limitations on reprocessing

Repeated reprocessing has minimal effect on the handpiece sleeve. End of life is normally determined by damage and wear due to use. We strongly recommend that the user regularly inspects the handpiece sleeve. The user is solely responsible for issues arising from the use of a damaged or worn handpiece sleeve.

Equipment and material

- Steam sterilizer (CE marking; valid IQ/OQ/PQ)
- Enzymatic detergent intended for cleaning of medical devices made of metal, glass and plastics
- Intermediate or low level disinfectant intended for surface disinfection of medical devices made of metal, glass and plastics; proven efficiency (e.g. FDA clearance, VAH/DGHM listing, CE marking)
- Potable tap water (unless national regulation requires differently)
- Soft, lint-free, non-abrasive, disposable cloth
- Soft, nylon-bristled brush
- Syringe
- Standard packaging material suitable for steam sterilization (temperature resistance up to at least 137°C (278.6°F), sufficient steam permeability)

Instructions

Point of use

- Immediately remove excess soil within semicritical area using a soft, lint-free, non-abrasive, disposable cloth.
- Reprocess within two hours maximum.

Preparation for decontamination

1. Disassemble handpiece sleeve from handpiece (*see Instructions for Use, Disassembling the handpiece sleeve (p. 19)*).
2. Transport handpiece sleeve to designated reprocessing area (there are no requirements on containment and transportation).

Cleaning: Automated

Automated cleaning has not been validated since users do not have the equipment to clean automatically. Therefore, automated cleaning must not be applied to the handpiece sleeve.

Instructions

Cleaning: Manual

1. Select specific enzymatic detergent so that they comply with the equipment description of this procedure. Follow their instruction for use in terms of storage, concentration, application, temperature and post-rinsing.
2. Immerse handpiece sleeve in enzymatic detergent and soak as described in its instructions for use.
3. Unless no residues are visible, thoroughly brush handpiece sleeve completely with a soft, nylon-bristled brush.
4. Use a syringe filled with detergent to flush all hard-to-reach areas of the handpiece sleeve.
5. Thoroughly rinse handpiece sleeve as described in the enzymatic detergent's instructions for use.
6. Dry using a fresh, soft, lint-free, non-abrasive, disposable cloth. Use a blotting motion for the optics.

Disinfection: Manual

- Select intermediate or low level disinfectant so that they comply with the equipment description of this procedure. Follow their instruction for use in terms of storage, concentration, application, temperature and post-rinsing.

Drying

If additional drying is necessary, rest handpiece sleeve on a clean place at room temperature until it is completely dry.

Maintenance

Discard blunt or damaged instruments.

Inspection and Testing

- Visually inspect for damage and wear (e.g. for scratches, discoloration, corrosion).
- Check that there is neither clouding nor scratches on the optics.
- In case of doubt, conduct an integrity check (see Instructions for Use, *Setting up the scanner (p. 16)*).
- Replace handpiece sleeve in case of damage and wear (e.g. deep scratches, corrosion, failed integrity check).

Instructions

Packing

A standard packaging material shall be used. Ensure that the pack is large enough to contain the handpiece sleeve without stressing the seals.

Sterilization

1. Select steam sterilizer so that they comply with the equipment description of this procedure. Follow their instruction for use in terms of validation, loading weight, operating time and functional testing.
2. Select fractionated vacuum method (with sufficient device drying), minimum of 3 minutes at 132°C (270°F).
3. Do not exceed 134°C (273°F).

Storage

The handpiece sleeve shall be stored dry and free of dust in the sterilization packing.

Additional Information

The Instructions for Use contains more detailed descriptions and figures on assembly/disassembly to handpiece, integrity check, transportation, handling (including storage), disposal, technical data, ambient temperature etc.

Manufacturer Contact

See the Instructions for Use back cover.

Fundamental suitability of the handpiece sleeve (initial state and after repeated reprocessing) and the instructions provided above for effective reprocessing have been validated by an independent government accredited and recognized test laboratory using the equipment specified in the test report, CIDEZYME®/Enzol® (both ASP Johnson & Johnson) and ProSpray™ Wipes (Certol® International).

Non-detraction of functionality was demonstrated in repeated processing using the equipment specified in the test report, CIDEZYME®/Enzol® (both ASP Johnson & Johnson) and ProSpray™ Wipes (Certol® International). In addition, it has been validated by Dental Wings using the aforementioned equipment and material, Bacillol® 30 Foam (Bode Chemie), Isopropanol 70% (Jedmon Products Ltd.), ProSpray C-60™ (Certol® International), COEffect™ Minute Spray (GC AMERICA INC.), BioSonic® WIPE OUT (Coltène/Whaledent Inc.).

The instructions given have been validated by Dental Wings as being capable of preparing the Intraoral Scanner handpiece sleeve for re-use. It remains the responsibility of the user to ensure that the reprocessing as actually performed using equipment, material and personnel in the dental or reprocessing facility achieves the desired result. This requires validation and routine monitoring of the process. Likewise, any deviation by the user from the instructions provided is performed under sole responsibility of the user and should be properly evaluated for effectiveness and potential adverse consequences.

Date issued: March, 2019

Appendix B - Reprocessing of the Intraoral Scanner (without handpiece sleeve)

Manufacturer: Dental Wings Inc.

Method: Intermediate or low level disinfection

Device: Intraoral Scanner handpiece (without sleeve), scanner unit and accessories

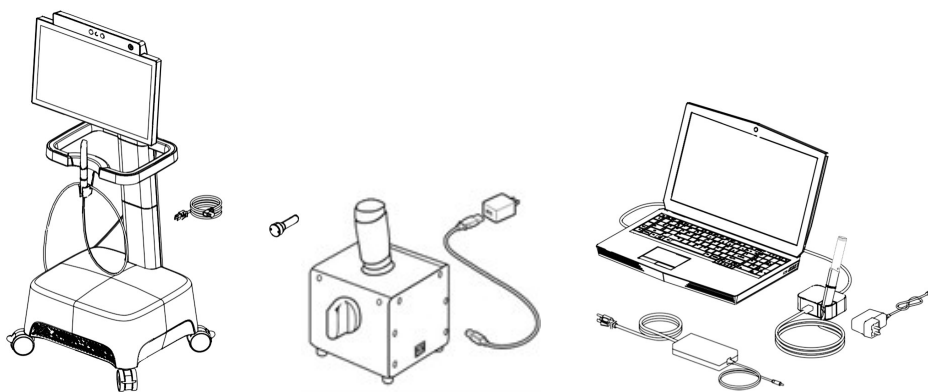

Figure 22: Scanner & accessories (without sleeve)

Precautions

- Do not autoclave.
- Never immerse the handpiece (without sleeve) in liquids.
- Do not use abrasive cleaners.
- Scratches on the optics cause damage to the handpiece (without sleeve). Be very careful when applying the soft, nylon bristled toothbrush. Do not rub cloth against optics. Use a blotting motion.
- Protect personnel and surroundings from contamination while brushing.
- Do not use corrosive cleaning agents or disinfectants with acids, bases, oxidizing agents, and solvents (with the exception of simple alcohol).
- Do not rinse the handpiece (without sleeve) or the scanner unit.
- Make sure the handpiece (without sleeve) is completely dry before assembled.
- Make sure the scanner unit is completely dry before plugged into power outlet.

Limitations on reprocessing

Repeated reprocessing has minimal effect on the Intraoral Scanner (without handpiece sleeve). End of life is normally determined by damage and wear due to use. We strongly recommend that users regularly inspect the Intraoral Scanner (without handpiece sleeve). Users are solely responsible for issues arising from the use of damaged or worn Intraoral Scanner (without handpiece sleeve).

Equipment and material

- Enzymatic detergent intended for cleaning of medical devices made of metal, glass and plastics
- Intermediate or low level disinfectant intended for surface disinfection of medical devices made of metal, glass and plastics; proven efficiency (e.g. FDA clearance, VAH/DGHM listing, CE marking)
- Potable tap water (unless national regulation requires differently)
- Soft, lint-free, non-abrasive, disposable cloth

Instructions

Point of use

- Immediately remove visible soil using a soft, lint-free, non-abrasive, disposable cloth.
- Reprocess within two hours maximum.

Preparation for decontamination

- Unplug scanner (*see Instructions for Use, Unplugging the scanner unit (p. 20)*).
- Disassemble handpiece (without sleeve) from scanner (*see Instructions for Use, Disconnecting the handpiece (p. 19)*).
- Transport handpiece (without sleeve), scanner unit and accessories to designated reprocessing area (there are no requirements on containment and transportation).
- Select specific intermediate or low level disinfectant according to its instructions for use. Follow it in terms of storage, concentration, application and temperature.

Cleaning: Automated

Automated cleaning must not be applied for the Intraoral Scanner (without handpiece sleeve).

Instructions

Cleaning: Manual

1. Clean handpiece (without sleeve) with a soft, lint-free, non-abrasive cloth, moistened with potable tap water.
2. Clean the handpiece area that had been covered by the handpiece sleeve with a soft, lint-free, non-abrasive, disposable cloth moistened with enzymatic detergent.
3. While the area is still wet, thoroughly brush it with a soft, nylon-bristled toothbrush, unless no residues are visible.
4. Clean the area at least for a minimum of three (3) times one (1) minute in duration with a soft, lint-free, non-abrasive cloth, moistened with potable tap water.
5. Clean scanner unit and accessories with a soft, lint-free, non-abrasive cloth, moistened with potable tap water.

Disinfection: Automated

Automated disinfection must not be applied for the Intraoral Scanner (without handpiece sleeve).

Disinfection: Manual

Apply intermediate or low level disinfectant as described in the disinfectant's instructions for use. Use a soft, lint-free, non-abrasive, disposable cloth for wiping.

Drying

Dry at room temperature until completely dry.

Maintenance

Maintenance is not applicable.

Inspection and Testing

- Visually inspect for damage and wear (e.g. for scratches, discoloration, corrosion).
- Check that there is neither clouding nor scratches on the optics of the handpiece (without sleeve).
- In case of doubt, conduct an integrity check (see Instructions for Use, *Setting up the scanner* (p. 16)).
- Replace handpiece (without sleeve) in case of damage and wear (e.g. deep scratches, corrosion, failed integrity check).

Sterilization

Sterilization must not be applied for the Intraoral Scanner (without handpiece sleeve). Sterilization is not required (the Intraoral Scanner (without handpiece sleeve) is classified noncritical).

Instructions

Packaging/Storage

No requirements in particular. If the handpiece (without sleeve) is stored on the scanner unit, cover it with an open see-through sterilization pouch. A size of 9 cm x 20 cm is required. A standard plastic bag may be used to store the complete handpiece. A minimum size of 25 cm x 40 cm is required.

Additional Information

Consult the Instructions for Use for more details.

Manufacturer Contact

See the Instructions for Use back cover.

Fundamental suitability of the handpiece (initial state and after repeated reprocessing) and the instructions provided above for effective reprocessing has been validated by an independent government accredited and recognized test laboratory using the equipment specified in the test report, CIDEZYME®/Enzol® (both ASP Johnson & Johnson) and ProSpray™ Wipes (Certol® International).

Non-detraction of functionality was demonstrated in repeated reprocessing using the equipment specified in the test report, CIDEZYME®/Enzol® (both ASP Johnson & Johnson) and ProSpray™ Wipes (Certol® International). In addition, it has been validated by Dental Wings using the aforementioned equipment and material, Bacillol® 30 Foam (Bode Chemie), Isopropanol 70% (Jedmon Products Ltd.), ProSpray C-60™ (Certol® International), COeffect™ Minute Spray (GD AMERICA INC.), BioSonic® WIPE OUT (Coltène/Whaledent Inc.).

The instructions given have been validated by Dental Wings as being capable of preparing the Intraoral Scanner handpiece for re-use. It remains the responsibility of the user to ensure that the reprocessing as actually performed using equipment, material and personnel in the dental or reprocessing facility achieves the desired result. This requires validation and routine monitoring of the process. Likewise, any deviation by the user from the instructions provided is performed under sole responsibility of the user and should be properly evaluated for effectiveness and potential adverse consequences.

Date issued: March, 2019

Appendix C - Electromagnetic Compatibility Guideline

Guidance and manufacturer's declaration - electromagnetic emissions		
The Intraoral Scanner is intended for use in the electromagnetic environment specified below. The user of the Intraoral Scanner should assure that it is used in such an environment.		
Emission test	Compliance	Electromagnetic environment – guidance
RF emissions CISPR 11	Group 1	The Intraoral Scanner uses radio frequency (RF) energy only for its internal function. Therefore, its RF emissions are very low and are not likely to cause any interference in nearby electronic equipment.
RF emissions CISPR 11	Class B	The Intraoral Scanner is suitable for use in all establishments, including domestic establishments and those directly connected to the public low voltage power supply network that supplies buildings used for domestic purposes.
Harmonic emissions IEC 61000-3-2	Class A	
Voltage fluctuations/ flicker emissions IEC 61000-3-3	Complies	

Table 1

Guidance and manufacturer's declaration – electromagnetic immunity			
The Intraoral Scanner is intended for use in the electromagnetic environment specified below. The user of the Intraoral Scanner should assure that it is used in such an environment.			
Immunity Test	IEC 60601 test level	Compliance level	Electromagnetic environment – guidance
Electrostatic discharge (ESD) IEC 61000-4-2	± 8 kV contact	± 8 kV contact	Floors should be wood, concrete or ceramic tile. If floors are covered with synthetic material, the relative humidity should be at least 30%.
	± 2/4/8/15 kV air	± 2/4/8/15 kV air	
Electrical fast transient/burst IEC 61000-4-4	± 2 kV	± 2 kV	Mains power quality should be that of a typical commercial or hospital environment.
	100 kHz repetition frequency	100 kHz repetition frequency	
Surge IEC 61000-4-5	± 0.5/1 kV line to line	± 0.5/1 kV line to line	Mains power quality should be that of a typical commercial or hospital environment.
	± 0.5/1/2 kV line to ground	± 0.5/1/2 kV line to ground	

Voltage dips and interruptions IEC 61000-4-11	0% U _T ; 0.5 cycle at 0°, 45°, 90°, 135°, 180°, 225°, 270°, and 315°	0% U _T ; 0.5 cycle at 0°, 45°, 90°, 135°, 180°, 225°, 270°, and 315°	Mains power quality should be that of a typical commercial or hospital environment. If the user of the Intraoral Scanner requires continued operation during power shortages, it is recommended that the Intraoral Scanner be powered from an uninterruptible power supply or a battery.
	0% U _T ; 1 cycle and 70% U _T ; 25/30 cycles Single phase: at 0° 0% U _T ; 250/300 cycles	0% U _T ; 1 cycle and 70% U _T ; 25/30 cycles Single phase: at 0° 0% U _T ; 250/300 cycles	
Rated power frequency magnetic field IEC 61000-4-8	30 A/m 60 Hz	30 A/m 60 Hz	Power frequency magnetic fields should be at levels characteristic of a typical location in a typical commercial or hospital environment.
NOTE U _T is the a.c. mains voltage prior to application of the test level.			

Table 2

Guidance and manufacturer's declaration – electromagnetic immunity			
The Intraoral Scanner is intended for use in the electromagnetic environment specified below. The user of the Intraoral Scanner should assure that it is used in such an environment.			
Immunity Test	IEC 60601 test level	Compliance level	Electromagnetic environment – guidance
Portable and mobile RF communications equipment should be used no closer to any part of the Intraoral Scanner, including cables, than the recommended distance calculated from the equation applicable to the frequency of the transmitter.			
			Equation for distance calculation
Conducted disturbances induced by RF fields IEC 61000-4-6	3 V	3 V	$d = 1.2 \sqrt{P}$
	0.15 MHz - 80 MHz	0.15 MHz - 80 MHz	
	6 V in ISM bands between 0.15 MHz – 80 MHz	6V in ISM bands between 0.15 MHz – 80 MHz	
	80% AM at 1 kHz	80% AM at 1 kHz	

Radiated RF EM fields IEC 61000-4-3	10 V/m 80 MHz - 2.7 GHz 80% AM at 1 kHz	10 V/m 80 MHz - 2.7 GHz 80% AM at 1 kHz	$d = 1.2 \sqrt{P}$ 80 MHz to 800 MHz $d = 2.3 \sqrt{P}$ 800 MHz to 2.7 GHz
Immunity to proximity fields from RF wireless communications equipment IEC 61000-4-3 (IEC61000-4-39)	IEC 60601-1-2:2014; Table 9	IEC 60601-1-2:2014; Table 9	$d = 6/E \sqrt{P}$ 380 MHz to 5.8 GHz
<p>P is the maximum output power rating of the transmitter in watts (W) according to the transmitter manufacturer and E is the Immunity Test Level (V/m), and d is the recommended separation distance in meters (m). Field strengths from fixed RF transmitters, as determined by an electromagnetic site survey,^a should be less than the compliance level in each frequency range.^b Interference may occur in the vicinity of equipment marked with the following symbol:</p> 			
<p>NOTE 1: At 80 MHz and 800 MHz, the higher frequency range applies.</p> <p>NOTE 2: These guidelines may not apply in all situations. Electromagnetic propagation is affected by absorption and reflection from structures, objects and people.</p>			
<p>a) Field strengths from fixed transmitters, such as base stations for radio (cellular/cordless) telephones and land mobile radios, amateur radio, AM and FM radio broadcast and TV broadcast cannot be predicted theoretically with accuracy. To assess the electromagnetic environment due to fixed RF transmitters, an electromagnetic site survey should be considered. If the measured field strength in the location in which the Intraoral Scanner is used exceeds the applicable RF compliance level above, the Intraoral Scanner should be observed to verify normal operation. If abnormal performance is observed, additional measures may be necessary, such as re-orienting or relocating the Intraoral Scanner.</p> <p>b) Over the frequency range 150 kHz to 80 MHz, field strengths should be less than 10 V/m.</p>			

Table 3

IEC 60601-1-2:2014, Table 9				
Band (MHz)	Service	P Max. power (W)	d Distance (m)	E Immunity test level (V/m)
380-390	TETRA 400	1.8	0.3	27

430-470	GMRS 460; FRS 460	2	0.3	28
704-787	LTE Band 13, 17	0.2	0.3	9
800-960	GSM 800/900; TETRA 800; iDEN 820; CDMA 850; LTE Band 5	2	0.3	28
2400-2570	Bluetooth; WLAN; 802.11 b/g/n; RFID 2450; LTE Band 7	2	0.3	28
5100-5800	WLAN 802.11 a/n	0.2	0.3	9

Table 4

Recommended separation distances between portable and mobile RF communications equipment and the Intraoral Scanner

The Intraoral Scanner is intended to be use in an electromagnetic environment in which radiated RF disturbances are controlled. The user of the Intraoral Scanner can help prevent electromagnetic interference by maintaining a minimum distance between portable and mobile RF communications equipment (transmitters) and the Intraoral Scanner as recommended below, according to the maximum output power of the communications equipment.

Rated maximum output power of transmitter (W)	Separation distance according to frequency of transmitter (M)		
	150 kHz to 800 MHz $d = 1.2 \sqrt{P}$	800 MHz to 2.7 GHz $d = 2.3 \sqrt{P}$	380 MHz to 5.8 GHz $d = 6/E \sqrt{P}$
0.01	0.12	0.23	N.A.
0.085 ¹	N.A.	N.A.	0.19
0.1	0.38	0.73	N.A.
0.352 ¹	N.A.	N.A.	0.13
1	1.2	2.3	N.A.
10	3.8	7.3	N.A.
100	12	23	N.A.

For transmitters rated at a maximum output power not listed above, the recommended separation distance d in meters (m) can be estimated using the equation applicable to the frequency of the transmitter, where P is the maximum output power rating of the transmitter in watts (W) according to the transmitter manufacturer.

NOTE 1: At 80 MHz and 800 MHz, the separation distance for the higher frequency range applies.

NOTE 2: These guidelines may not apply in all situations. Electromagnetic propagation is affected by absorption and reflection from structures, objects and people.

- 1) Maximum output power of the RF transmitter included in the Intraoral Scanner used in IEEE 802.11ac and 802.11n dual band (5 GHz).
- 2) Maximum output power of the RF transmitter included in the Intraoral Scanner used in IEEE 802.11g and 802.11n single band (2.4 GHz).

Table 5

www.dentalwings.com



Dental Wings Inc.

160 Rue St-Viateur E
Montreal QC H2T 1A8
CANADA

T +1 514 807-8485 (International)

T +1 888 856-6997 (North America)

F +1 514 223-3981

Intraoral Scanner Instructions for Use_EN
29-0100 v.4.2.1



Distributor stamp